

Zpětná zrcátka - Rückblickspiegel - Driving Mirrors

ZR1



Průměr :78 mm
Durchm.:78 mm

L5320=ZR1 Ch Kč 1930,- (AERO 30,50) - pro otevřené vozy
(für alle offene Wagen AERO 30,50) 1934-1947

ZR-1.. = Typ zrcátka, - Spiegel- Typ

Provedení , -Ausführung

Č - černě lakováno, schwarz lackiert,-black painted

Ni - niklováno,- vernickelt,- nickel plated

Ch - chromováno,- verchromt,-chrome plated



sklo,-Glas

ZR1 + DZR12

umístění na čelním skle při použití držáku DZR12,-Lage auf der Windschutzscheibe bei Verwendung Halter DZR12 -



DZR12

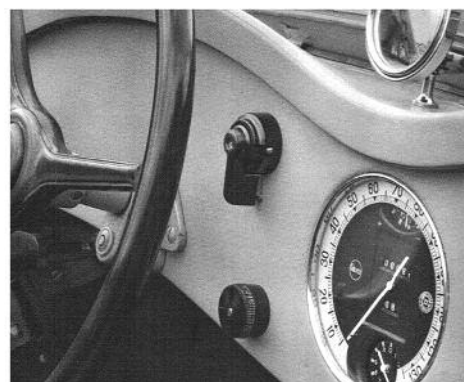

AERO 30,50 -umístění na vozidle,-
Positionen am Fahrzeug

ZR 2-A

1947 - 1955

TYP : A



50 x 110 mm

65 mm

ZR2-A-Ch Kč 2860,- ZR2-A-Ni Kč 2860,-



sklo,-Glas

ZR2A + DZR2-P



sklo,-Glas

ZR2A + DZR2A

ZR 2-D

1935 - 1947

TYP : D

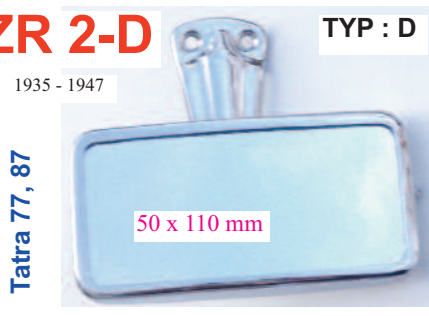

50 x 110 mm

75 mm

ZR2 - D- Ch Kč 2860,- ZR2 - D- Ni Kč2860,



sklo,-Glas

ZR2D + DZR2-P



sklo,-Glas

ZR2D + DZR2D

DZR2-P



Držák zrcátka na sklo - neotočný



DZR2D
(DZR2A)

Držák zrcátka na sklo otočný



sklo,-Glas

ZR2D + DZR2-P
Držák zrcátka na sklo,- Halterung
für Spiegel auf Glas



ZR2D + DZR2D
Držák zrcátka na sklo otočný,- Hal-
terung für die Montage auf dem Glas
schwenkbar -



ZR 2-B

TYP : B

ZR2-B-Ch Kč2660,-
 ZR2-B-Ni Kč2660,-



sklo,-Glas

ZR2B + DZR12

umístění na čelním skle při použití držáku DZR12,-Lage auf der Windschutzscheibe bei Verwendung Halter DZR12 -

ZR 2- BN

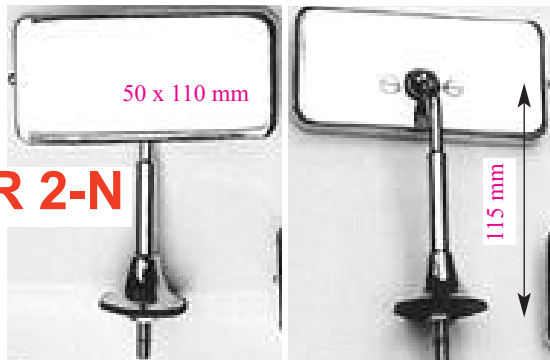

ZR 2-N

ZR2 N-ch Kč 2540,-



ZR2-BN
 doprodej,- *Schlussverkauf*



sklo Glas

ZR2B + DZR12



DZR12

Držák zrcátka na sklo - neotočný

ZR 2/17

Rozteč šroubů (Schraube distanc) pr.6 - 50 mm - Screw pitch



ZR2/17-Ch Kč 3760,-
 ZR2/17 -Ni Kč 3760,-



sklo,-Glas

ZR2/17 + DZR17

zpětné zrcátko překlápěcí (otočné - pro kabriolety)
 Rückblickspegel - Umdrehtbar,-
 fold mirror (rotary - for cabriolets)



DZR17

Držák pro montáž na sklo,-Halierung zur Montage auf Glas



sklo,-Glas

ZR2/17 + DZR17

umístění na čelním skle při použití držáku DZR17,-Lage auf der Windschutzscheibe bei Verwendung Halter DZR17 -

ZR 3

1938 - 1972

Průměr :101 mm,- Diameter: 101 mm
Durchm.:101 mm

Ni - niklováno,- vernickelt,- nickel plated

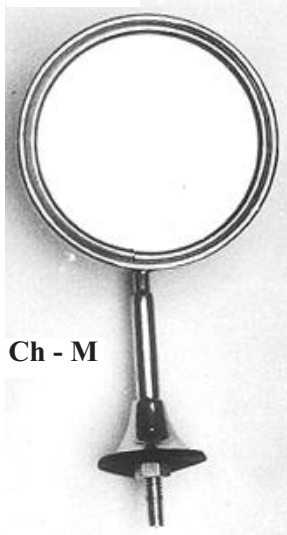

Ch - M

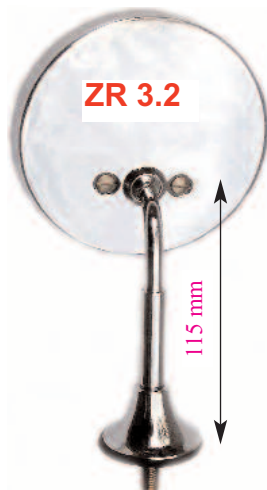

ZR 3.2

115 mm



ZR 3.3

115 mm



ZR 3.3 -P



ZR 3.2 Kč2370,-
ZR 3.2-Ni Kč2370,-

ZR 3.3 Kč2370,-
ZR 3.3-Ni Kč2370,-
ZR 3.3 -P Kč2330,-

ZR3B



ZR3-BZ



ZR3-BZ-P



ZR 3.3-D

ZR 3.3 - D = 180 mm

Rozteč šroubů (Schraube
distance) pr.5 - 30 mm

Průměr :101 mm
Durchm.:101 mm

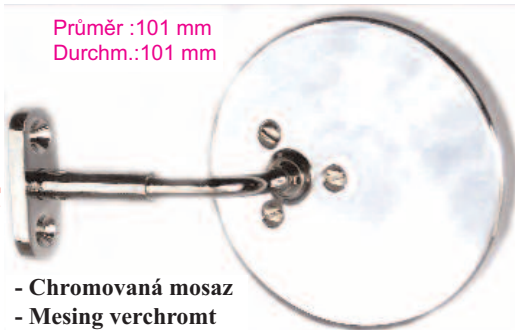

- Chromovaná mosaz
- Messing verchromt

ZR3 - B Kč2000,-
ZR3-BZ Kč2470,-
ZR3-BZ-Ni Kč2490,-

ZR3 - B-P Kč2000,-
ZR3-BZ-P Kč2470,-
ZR3-BZ-P-Ni Kč2490,-



G-ZR3-B Kč85,- náhradní pryž.podložka,-
Ersatz Gummi- Unterlegscheibe

G-ZR3 Kč85,- náhradní pryž.podložka
Ersatz Gummi- Unterlegscheibe
Spare rubber. washer

ZR3.3 - D Kč2450,-



(ZR 3) (ZR 3-P)

ZR3-B-doprodej
ZR3-BZ

ZR3-B-P-doprodej
ZR3-BZ-P

Nožka -P : umožňuje větší vytočení nutné u zrcátka na straně spolujezdce,-Stem-P ermöglicht eine grössere Aruf auf der Beifahrerseite Spiegel,- Foot-P enables a greater need to dial with a mirror on the passenger side, -

Zrcátko -Z : umožňuje změnu natočení podložky vůči nožce zrcátka,- Spiegel-Z. : Umlenkspiegel Pads Bein,- Mirror-Z allows you to change the rotation washers to stem mirrors -

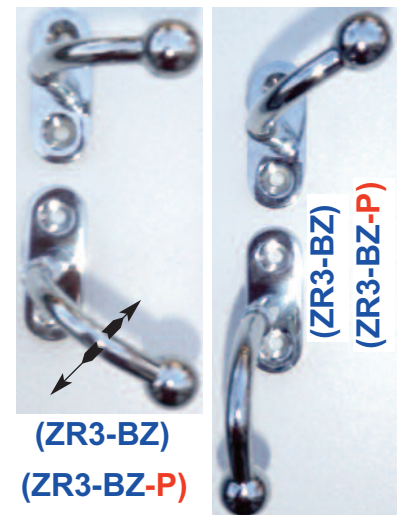

(ZR3-BZ)
(ZR3-BZ-P)

(ZR3-BZ)
(ZR3-BZ-P)

D-ZR3B

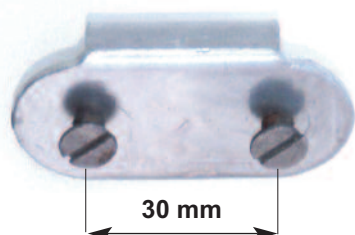

D-ZR3B-ZN Kč250,- Držák zrcátka zinkovaný,-
 Spigel halter -verzinkt

D-ZR3B-CH Kč450,- Držák zrcátka chromovaný,-
 Spigel halter -verchromt

D-ZR3B - držák zrcátka je určený pro montáž na plechovou hranu dveří a je vhodný pro zrcátka - ZR3B (nelze u nich měnit natočení nožky vůči podložce), nebo zrcátka - ZR3BZ a držáků - DR3 u kterých lze nastavit úhel natočení podložky vůči nožce a pak zajistit nastavenou polohu,-*Wand-Spiegel sind für die Montage auf dem Metall Rand der Tür konzipiert und eignet sich für Spiegel ZR3B, ZR3BZ, DR3.,-D-ZR3B - mirror holder is designed for mounting on the metal edge of the door and is suitable for mirror - ZR3B (can not they change the angle to the leg pad), or mirror - ZR3BZ and holders - DR3 where you can set the rotation angle and leg pads to ensure the positioning*



D-ZR3B + ZR3B-Z - nebo
D-ZR3B + ZR3B-B - oder

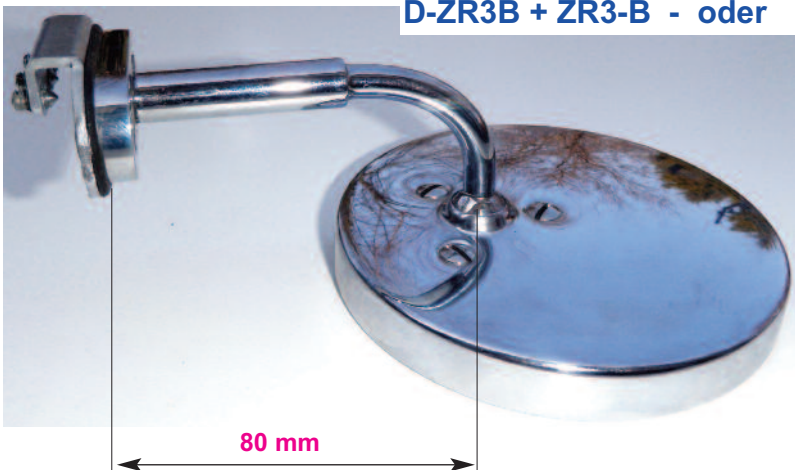

ZR3R

Průměr :101 mm
 Durchm.:101 mm



Zrcátko na rám dveří, uvádějte typ **-R**, nebo **L** a šířku **S**, - Der Spiegel auf dem Türrahmen, geben Sie den Typ **-R**-oder **L** und der Breite **S**

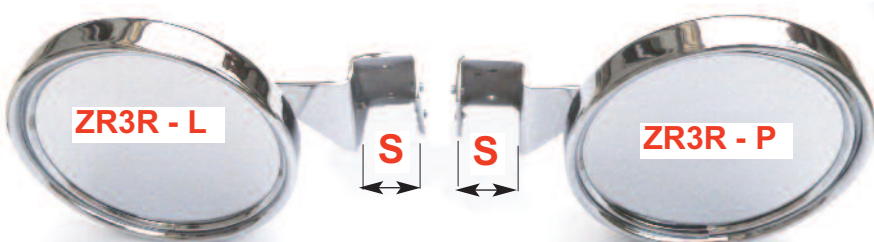

ZR3R-L- (S=) 22mm - Kč2030,- ZR3R-P- (S=) 22mm - Kč2030,-
 ZR3R-L-(S=) 25mm - Kč2030,- ZR3R-P- (S=) 25mm - Kč2030,-



Příklad montáže Tatra 87
 ZR3-L- šířka S v mm
 Einbaubeispiel Tatra 87
 ZR3-L-S Breite in mm



ZR3R-L



Příklad montáže Tatra 603, 613-1 ZR3R - šířka S v mm,-
 Beispiel ZR3R Montage Tatra 603, 613-1 .. S Breite in mm

Zpětná zrcátka a držáky - Spiegel und Halter - Mirrors and holders

- pro montáž do rámu bočního okna, - für den Einbau in die Seitenfensterrahmen, - for installation into side window frame

ZR3 - T -BZ



ZR3-T-BZ Kč2930,-

ZR3 - T -BZ-L



ZR3-T-BZ-P Kč2930,-

Zrcátko -Z :umožňuje změnu natočení podložky vůči nožce zrcátka,-

Spiegel-Z : Umlenkspiegel Pads Bein,-

Mirror-Z allows you to change the rotation washers to stem mirrors -

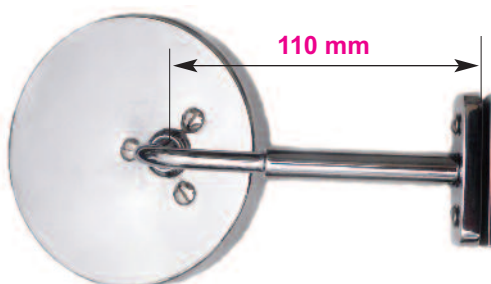

zrcátko ke spolujezdci (umožňuje větší vytočení)

Nožka -P : umožňuje větší vytočení nutné u zrcátka na straně spolujezdce,-Stem-P. ermöglicht eine grössere Aruf auf der Beifahrerseite Spiegel,- Foot-P enables a greater need to dial with a mirror on the passenger side, -

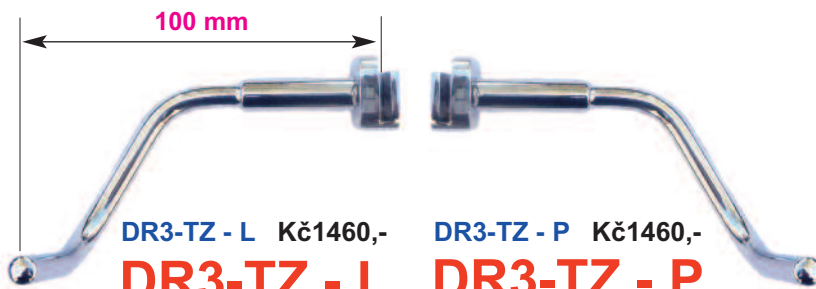
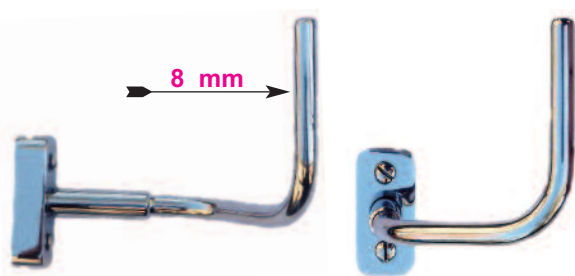

DR3-TZ - L Kč1460,-

DR3-TZ - L

DR3-TZ - P Kč1460,-

DR3-TZ - P



DR3-TZ + ZR4



DR3-TZ + ZR19B



příklad použití : DR3-TZ

Lze použít pro TATRU 77, 87, 97, 600, 57B, -Kann für Tatra 77, 87, 97, 600, 57B eingesetzt werden, -Can be used for Tatra 77, 87, 97, 600, 57B

ZR 4



ZR 4-C Kč1550,-

ZR 4-CH Kč1550,-



ZR 4-držák 390,-Kč - pro uchycení na karoserii
 Pr.13 x 17mm , -ZR 4-Halter 360,-CZK - für die Montage
 auf dem Körper Pr.13 x 17mm

Typy použitých skel pro zrcátka : ZR6, ZR7, ZR8, ZR9, ZR13, ZR14, ZR15, ZR17,



A - ostré rohy - Scharfe Ecken - sharp margin - 60x120 mm

C - zaoblené rohy - Abgerudete Ecken,- - 60x150 mm

B - zaoblené rohy - Abgerudete Ecken - round,- - 60x120 mm

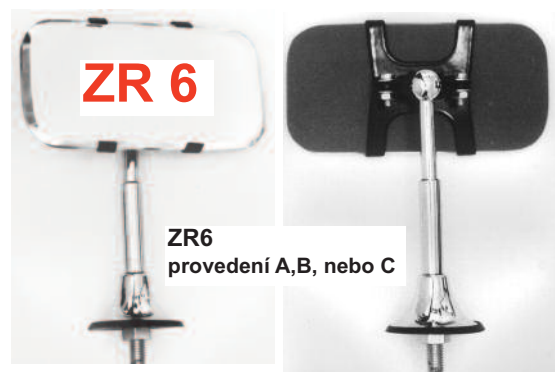

ZR6 Kč1360,-



Rozteč šroubů , -Schraube
 distanc : 32 mm - Screw pitch



ZR7 Kč1490,-

ZR7-Ch-N. Kč1710,- Chromovaná noha,-Chrome Leg

ZR7-Ni-N. Kč1710,- Niklovaná noha,-Vrnickelt Leg



ZR7B-2xCh



ZR7C-2xCh

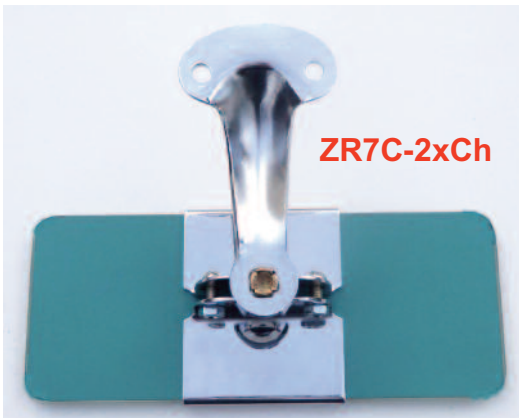

ZR7-2xCh Kč1940,- *Kompletně chromovaná,-komplett verchromt* ZR7-2xNi Kč1840,- *Kompletně niklovaná,- K.v.n.*

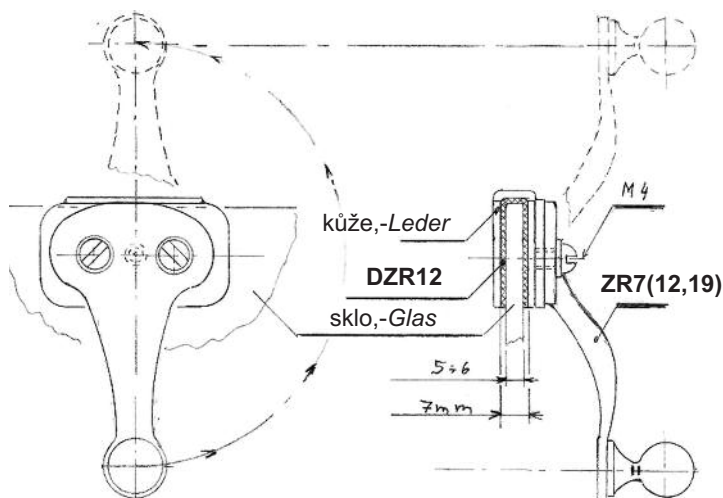

sklo,-Glas

DZR7
 otočný držák,-
 Schwenkconsole



DZR7- P
 neotočný držák,- Nicht-
 Spiegelrotation

umístění na čelním skle při použití otočného držáku DZR12,-Lage auf
 der Windschutzscheibe bei Verwendung Halter DZR12 -



sklo,-Glas

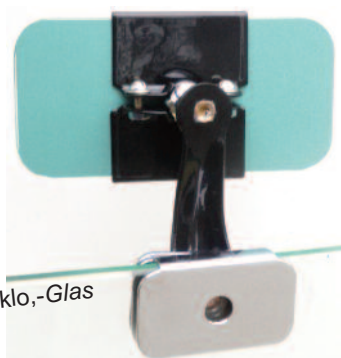

sklo,-Glas



ZR7B + DZR7

DZR7 - je otočný a umožňuje vytočit nahoru pro použití v karioletech,- DZR7 - ist drehbar und somit Wahl für die Verwendung in einem Cabrio

*Přehled a ceník držáků je uveden na konci,-
 Übersicht und Preise - Halter wird am Ende*

ZR 8

1927- 1940



ZR8 Kč1570,- pro sklo síly 3-13mm,- Glasstärke von 3 bis 13 mm,- Glass strength from 3 to 13 mm ,
ZR8-S Kč1570,- pro rám síly 3-25mm,- Kräfte für den Rahmen 3 bis 25 mm,- forces for frame 3 to 25 mm



ZR 9

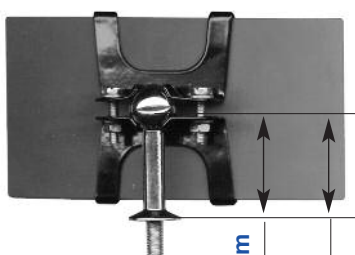

ZR9 A Kč1230,-
ZR9-K Kč1230,-



ZR9 B + DZR12



ZR9 B - K + DZR12

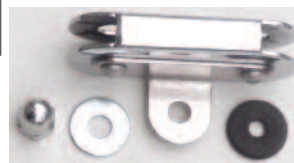

DZR12

Držák zrcátka na sklo,- Halterung für Spiegel auf Glas

ZR9 Kč1230,
provedení A,B, nebo C viz. ZR 7

ZR 10-A

Pr.105 mm



ZR10 -A Kč 1810,-
Chromováno + černá,verchromt und schwarz lackiert

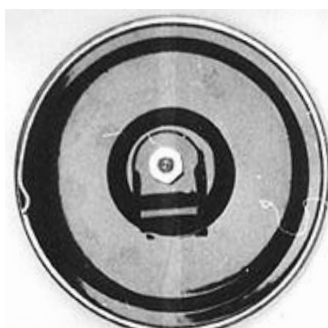

ZR10 -A-Ch Kč 2000,-
Chromováno ,verchromt

uvádějte průměr 8, nebo 10 mm ,
bestellen Sie Durchmesser 8 oder 10 mm



ZR 10A-
držák-C

ZR 10-B

Pr.105 mm

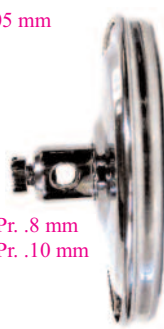

ZR10 -B Kč2090,-
Chromováno + černá, verchromt und schwarz lackiert



ZR10 -B-Ch Kč2250,-
Chromováno ,verchromt



ZR 10B-
držák-CH

uvádějte průměr 8, nebo 10 mm ,
bestellen Sie Durchmesser 8 oder 10 mm,-
give diameter 8 or 10 mm

DR-ZR10A-držák-C 340,-Kč - pro uchycení na karoserii průměr 8,nebo10 mm
DR-ZR10A-držák-CH 470,-Kč - pro uchycení na karoserii průměr 8,nebo10 mm chromovaný,-,verchromt,-

DR-ZR10B-držák-CH 600,-Kč - pro uchycení na karoserii průměr 8mm
DR-ZR10B-držák-CH 600,-Kč - pro uchycení na karoserii průměr 10 mm (Pr.20 x 20mm),- für die Montage auf dem Körper von 10 mm Durchmesser (Pr.20 x 20mm -for holding on the car body



ZR 12

1927-1937
 122x63 mm

použito u většiny vozů PRAGA,- verwen-
 det in den meisten Autos PRAGA



ZR12-CH Kč 3010,
 ZR12-NI Kč 3010,



ZR12-Č Kč 2450,
 (= černě lakováno)
 schwarz lackiert,-
 Black color



+ chromovaná ,nebo
 niklovaná noha

ZR12-2xCH Kč 3250,
 ZR12-2xNI Kč 3250,



Umístění zrcátka ZR12 na voze
 AERO 1000,- Platzieren von
 Spiegel ZR12 auf dem AERO 1000



ZR 12

= A10043 Zpětné zrcátko před řidiče a na
 blatník (AERO 500,662,1000)
 - Rückblickspiegel innere for den Führer
 und äussere auf das Kotflügel
 Driving mirror in front of driver and for
 mudwing

DZR7
 otočný držák,-
 Schwenkconsole



DZR7- P
 neotočný držák,- Nicht-
 Spiegelrotation



ZR12 + DZR7

sklo,-Glas

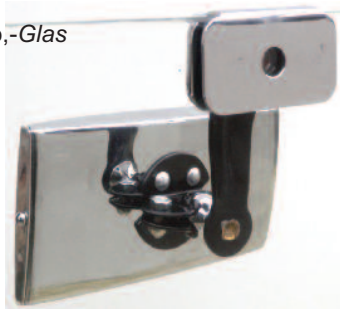

DZR7 - je otočný a umožňuje vytočit nahoru pro použití v kabrioletech,-
 DZR7 - ist drehbar und somit Wahl für die Verwendung in einem Cabrio



sklo,-Glas



ZR12 + DZR7 - P



ZR 12-N

65x122 mm

ZR12-N-Ch Kč2830,-



ZR12-N-Ni Kč2830,-



sklo,-Glas



ZR12-N-Č Kč2250,-



ZR 12-CH - 0

ZR12-CH- 0 Kč 2740,
 -bez nožky,- ohne Fuss

sklo,-



ZR12N + DZR12

DZR12- P
 neotočný držák,- Nicht-
 Spiegelrotation

Zrcátko pro montáž na čelní sklo,-Spiegel für montage
 an Glas,-The mirror mount on the windshield -

ZR 12/8

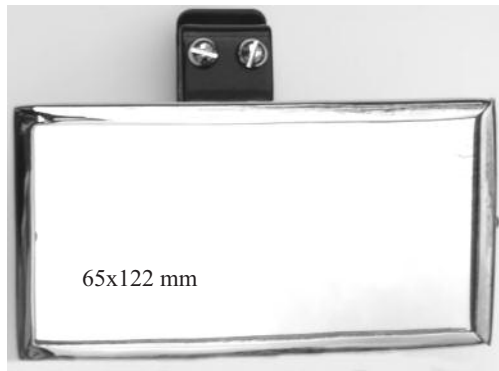

ZR12/8-CH Kč 3020,- pro sklo síly 3-13mm,- für Glasstärke bestimmt sind
 ZR12/8-Ni Kč 3020,- pro sklo síly 3-13mm

zpětné zrcátko překlápěcí (otočné - pro kabriolety)
 Rückblickspiegel - Umdrehtbar,-
 fold mirror (rotary - for cabriolets)



ZR 12/16

122x63 mm

ZR12/16 -Ch Kč 3080,-
 ZR12/16 -Ni Kč 3080,-



Pr.5 - 51mm



ZR12/16 -2xCh Kč3570,-

chromovaný držák pro ZR12/16,-
 verchromthalter für ZR12/16

ZR12/8 -CH Kč 3020,-
 pro rám síly 3-25mm
 ZR12/8 -Ni Kč 3020,-
 pro rám síly 3-25mm

Náhradní skla pro zrcátka
 Ersatz Glas für Konvexspiegel
 Spare glass for mirrors

TYP	velikost Grösse Size	křivost Krümmung curvatura	Kč
ZR1	ř70mm.	R450	Kč 215
ZR3	ř92mm.	R450	Kč 215
ZR10	ř95mm.	R450	Kč 215
ZR12	117x60	R450	Kč 380
ZR2	115x56	R1350	Kč 380
ZR19	114x58	R450	Kč 380
ZR20	154x76	R450	Kč 430

ZR7,8,17, -A 60x120 mm Kč 400
 ZR7,8,17, -B 60x120 mm Kč 400
 ZR7,8,17, -C 60x150 mm Kč 400
 60x190 mm Kč 400

ZR16,13,14,15 65x150 mm Kč 400
 ZR16,14,15 70x180 mm Kč 400



sklo,-Glas

ZR12/16 + DZR16



sklo,-Glas



sklo,-Glas



sklo,-Glas

ZR12/16 + DZR16

ZR 13 1920-1935

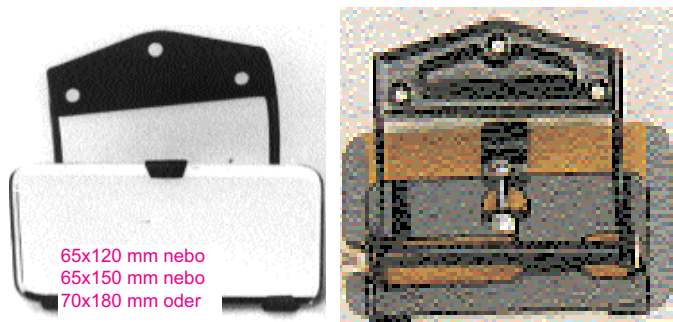

65x120 mm nebo
 65x150 mm nebo
 70x180 mm oder

ZR 13-L

ZR 13-P

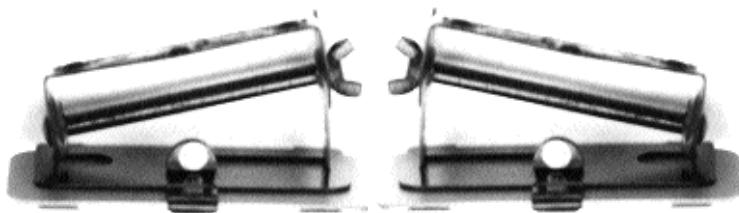

ZR13-L =volant na levé straně,- = Lenkrad links Kč1250,-
 ZR13-P =volant vpravo,- = Lenkrad rechts Kč1250,-
 = steering wheel to the right -

ZR 14 39

1925-1935



ZR14 Kč1340,-
 ZR14-Ch-N Kč1440,-Chromovaná noha

ZR 15 25

1925-1935

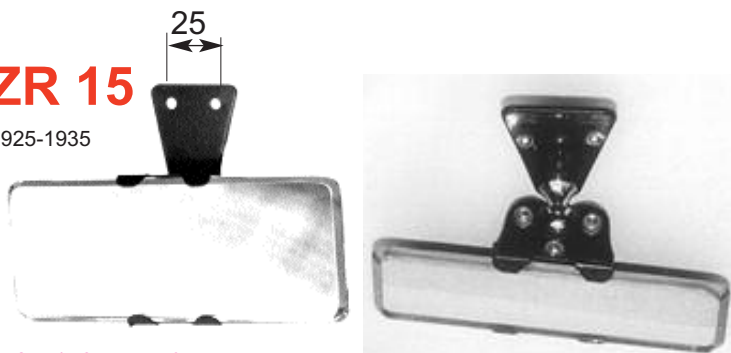

65x150 mm nebo
 70x180 mm oder, ..

ZR15 Kč1340,-
 ZR15-Ch-N Kč1440,-Chromovaná noha,-
 Chrome Bein,- Chrome leg-

Zpětná zrcátka - Rückblickspiegel - Driving Mirrors
 - otočná pro kabriolety,- schwenken-Spiegel für Cabrios,- Swivel for cabriolets

ZR 16

1927- 1940

65x120,65x150 nebo,
 oder 70x180 mm

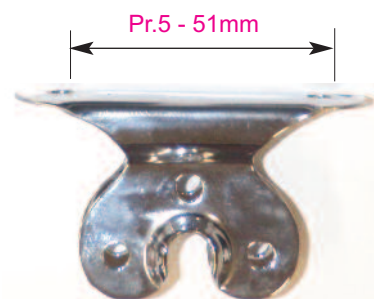
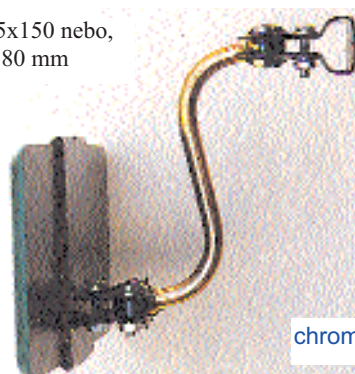

chromovaný držák pro ZR16,-verchromthalter für ZR16

ZR16 Kč2280,-
 nožka -chromovaná, niklovaná, nebo leštěná mosaz
 der Fuss - verchromt, vernickelt oder polierte Messing

zpětné zrcátko překlápěcí (otočné)
 Rückblickspiegel - Umdrehtbar
 pro kabriolety

ZR16-2xCH Kč2790,-
 nožka + držák chromovaný, držák skla černý
 der Fuss +Halter verchromt ,Glashalter
 schwarz lackiert



ZR16 + DZR16



sklo,-Glas



DZR16

Zpětná zrcátka - Rückblickspiegel - Driving Mirrors - otočná pro kabriolety,- schwenken-Spiegel für Cabrios,- Swivel for cabriolets

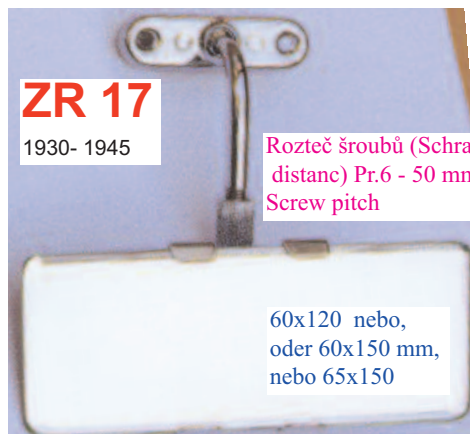

ZR 17

1930- 1945

Rozteč šroubů (Schraube
 distanc) Pr.6 - 50 mm -
 Screw pitch

60x120 nebo,
 oder 60x150 mm,
 nebo 65x150

ZR17 -M-Ch
 ZR17 -M-Ni

Kč3580,-
 Kč3580,-

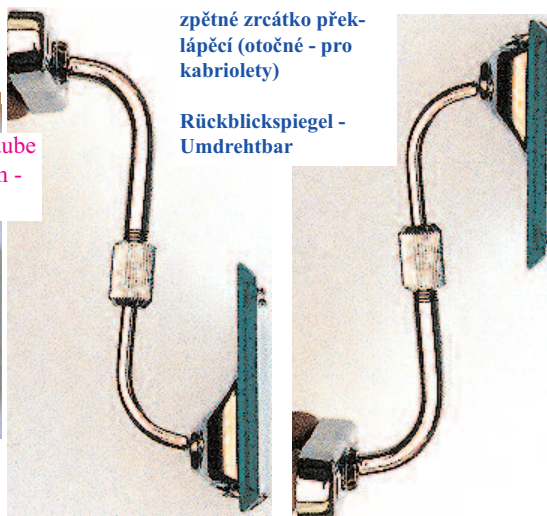

zpětné zrcátko přek-
 lápěcí (otočné - pro
 kabriolety)

Rückblickspiegel -
 Umdrehbar



ZR17 + DZR17

sklo,-Glas



ZR17/3

60x150 mm

ZR17/3 -Ch

Kč2550,-



sklo,-Glas

ZR17 + DZR17

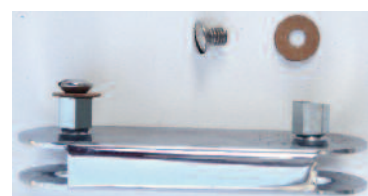

**DZR17 - neotočný držák,-
 Nicht-Spiegelrotation Halter**

ZR17 + DZR17



Zpětná zrcátka - Rückblickspiegel - Driving Mirrors



ZR19

61 x 117 mm

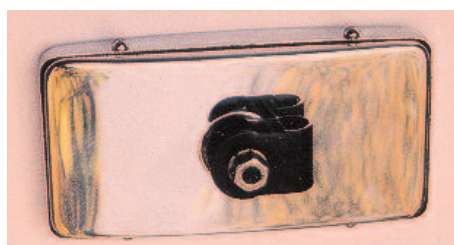

ZR19-A

ZR19-A-Ch
 ZR19-A-Ni

Kč 2560,-
 Kč 2560,-

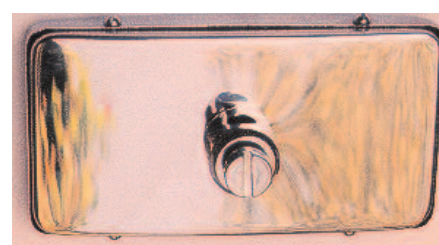

ZR19-B

ZR19-B-Ch
 ZR19-B-Ni

Kč 2860,-
 Kč 2860,-

Provedení - Ausführungen- : A, B, C, N,

diametr off hole for Holder :

Typ : A-průměr /durchm/-5/16" /8mm/
 nebo,oder-3/8" /10mm/
 - 7/16"
 - 1/2" /12mm/

Typ : B-průměr /durchm/ 8mm,nebo10mm

Zrcátka anglického typu (různé držáky)
 Spiegel - Englisch Typ - verschiedene Halter
 Mirrors - English Type - Varios holders

ZR19- 0



ZR19-0-Ch
 ZR19-0-Ni

Kč 2760,-
 Kč 2760,-

ZR19-C



ZR19-C-Ch Kč 3030 ,-
 ZR19-C-Ni Kč 3030 ,-
 ZR19-C-2xCh Kč 3270 ,-(= +chromovaná noha),-Chrom Fuß
 ZR19-C-2xNi Kč 3270 ,-

ZR19-C + DZR 7



ZR19-C + DZR 7P



DZR7
 otočný držák,-
 Schwenkconsole

ZR19-N

ZR19-N-Ch Kč 2850 ,-
 ZR19-N-Ni Kč 2850 ,-



ZR19-N + DZR 12



ZR19/17

ZR19/17-CH Kč 3770 ,- ZR19/17-Ni Kč 3770 ,-

ZR19/16 + DZR 16

ZR19/17 + DZR 17



ZR19/16-2xCH



ZR19/16-CH

umístění na čelním skle při použití držáku DZR16,-Lage auf der Windschutzscheibe bei Verwendung Halter DZR16 -



umístění na čelním skle při použití držáku DZR17,-Lage auf der Windschutzscheibe bei Verwendung Halter DZR17 -

ZR19/16-2xCh Kč 3590 ,- zpětné zrcátko překlápěcí (otočné - pro kabriolety),-
 ZR19/16-CH Kč 3100 ,- Rückblickspiegel - Umdrehbar
 ZR19/16-Ni Kč 3100 ,- fold mirror (rotary - for cabriolets)



ZR19-VN

ZR19-VN-Ch Kč 2570,-

ZR19/8



ZR19/8-Ch Kč 3050,-

Zrcátka pro montáž na čelní sklo,-
Spiegel für montage an Glas



ZR19/8-Ni

Kč 3050,-

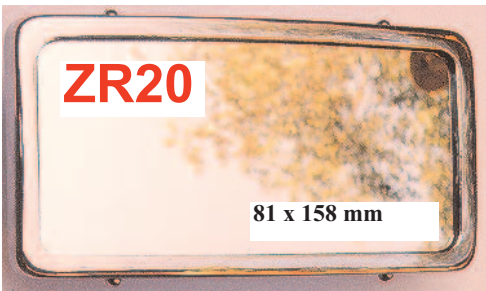

ZR20

81 x 158 mm

Provedení - Ausführungen- : A, B, C, N,



ZR20-A

Originální držák zrcátka ZR20-A
-nedodáváme,- -Nicht verfügbar



ZR20-A



ZR20-B

Chromováno,nebo niklováno, Verchromt oder vernickelt ,

Provedení - Ausführungen- : A, B, C, N,

ZR20-A-CH Kč 3330,-
ZR20-A-Ni Kč 3330,-
ZR20-B-CH Kč 2850,-
ZR20-B-Ni Kč 2850,-
ZR20-C-CH Kč 3050,-
ZR20-C-Ni Kč 3050,-
ZR20-N-CH Kč 2950,-
ZR20-N-Ni Kč 2950,-



ZR20-C



ZR20-N

Zrcátka anglického typu (různé držáky)
Spiegel - Englisch Typ - verschiedene Halter
Mirrors - English Type - Various holders

diametr off hole for Holder :
Typ : A-průměr /durchm/-5/16" /8mm/
nebo,oder-3/8" /10mm/
- 7/16"
- 1/2" /12mm/
Typ : B-průměr /durchm/ 8mm,nebo10mm

VW 211857513

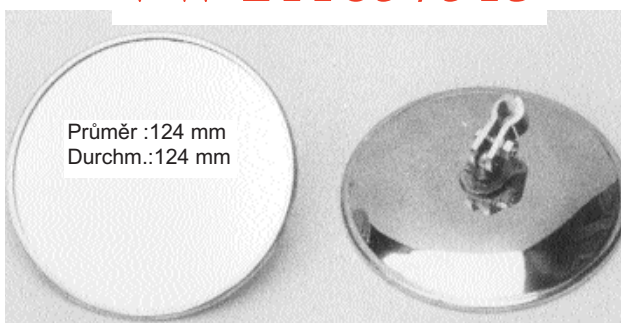

Průměr :124 mm
Durchm.:124 mm

Kč 1060,- Zpětné zrcátko pro (do roku 67)

VW-BUS - VW 211857513

Rückblickspiegel für VW-Kombi - VW 211857513

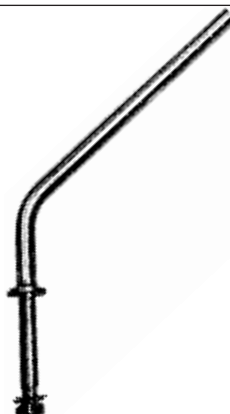

Kč 410,- držák zrcátka VW

Rückblickspiegelhalter

Zpětná zrcátka + držáky AERO 30,50 - Rückblickspiegel + Halter (AERO 30, 50)



Príklady použití držáků DRA-1, DRA-1K na otevřených vozech AERO -lze použít pouze na straně u řidiče,- DRA-1K+ZR19- 0
 Beispiele für die Verwendung von Klammern DRA-1, können DRA-1K auf offenen AERO-Fahrzeuge nur auf der Fahrerseite verwendet werden, -

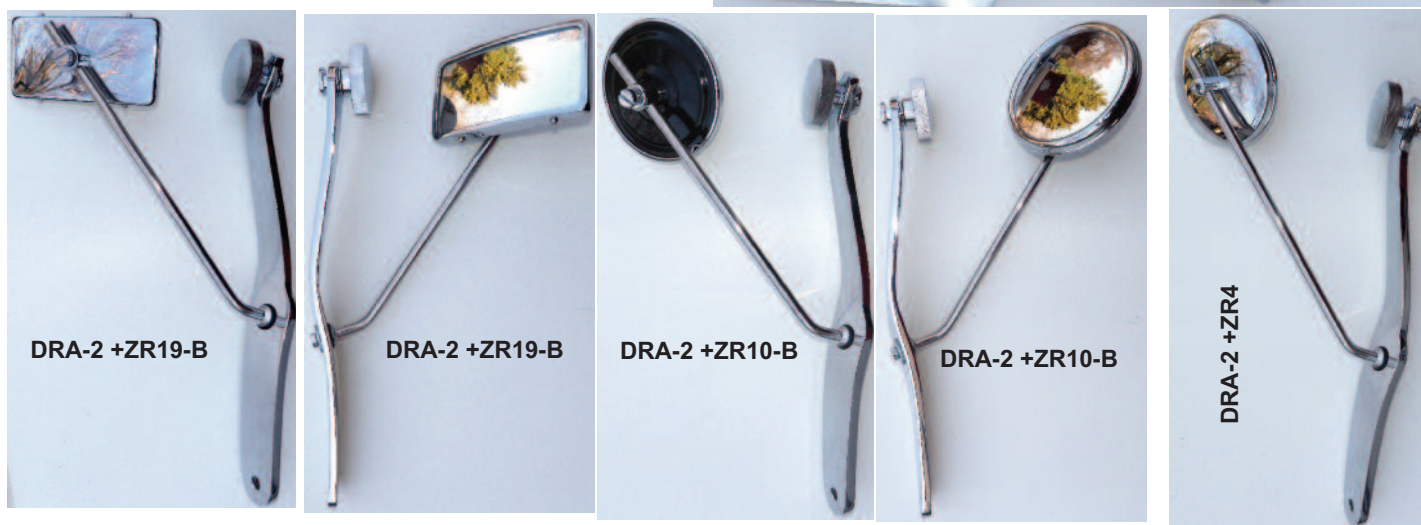

Príklady použití držáku DRA-2, na otevřených vozech AERO -lze použít na obě strany,-
 Beispiele für mit dem Halter DRA-2, können die AERO-offenen Wagen auf beiden Seiten verwendet werden -



Príklady použití držáku D-ZR3B, na limusínách AERO (montáž na rám dveří)-
 Beispiele für die Verwendung von D-Halterung ZR3B auf limusínách AERO (angebracht am Türrahmen), -

Zpětná zrcátka + držáky - Mirrors + Halter

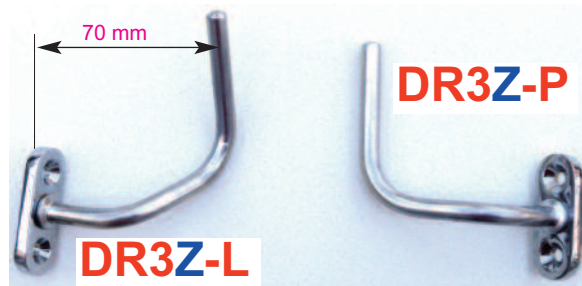

DR3Z-L Kč 1210,-

DR3Z-P Kč1150,- Držák zrcátka umožňující natočení nožky proti podložce, a v kombinaci s držákem DZR3-B i uchycení na plecovou hranu dveří,- Spiegelhalter eine Drehung der Füße auf die Matte, und in Kombination mit einem Halter DZR3-B Blatt und Anbringen der Kante der Tür -

Držák -Z :umožňuje změnu natočení podložky vůči nožce , - Halter-Z können Sie die Drehung auf die Bein-Pads, ändern -

DRA-3:Vhodný pro ZR4, ZR10, ZR19,- Geeignet für ZR4, ZR10, ZR19



G-ZR3-B - pryž.podložka,je součástí držákuDR3,-Gummi. Unterlegscheibe Teil des Halters DR3-L(R)



DR4-P Kč 870,-

DR4-L Kč 870,-



DR-4P + ZR19-B + DRZR10B

DR-4L + ZR4 + DRZR4

Příklady použití držáku DR4 , - Beispiele für die Verwendung der Halterung DR4



DRZR10-A-C Kč 340,-
 DRZR10-A-CH Kč 470,-

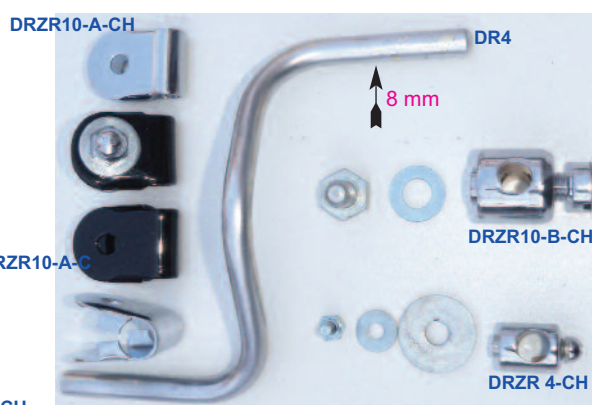

DRZR10-B-CH Kč 610,-
 DRZR10-A-Ni Kč 610,-

DRZR4-CH Kč 400,-
průměr/durchm. : 8 mm

průměr/durchm. : 8, 10, mm (7/16", 1/2")

Držáky k upevnění zpětných zrcátek na čelní sklo,-Halterungen zur Befestigung Spiegel an der Windschutzscheibe,-Holders for fixing mirrors on the windshield



DZR2- P

DZR2-P neotočný držák,- Nicht-Spiegelrotation

DZR2-P Kč 550,- ..rozteč šroubů,-Abstand der Bolzen,- spacing of of screws = 21 mm

pro zrcátka,-für Spiegel,-for mirrors : **ZR 2A, ZR 2D**

DZR 2

otočný držák,-Schwenkkonsole

DZR2A Kč 790,- ..rozteč šroubů = 20 mm - Screw pitch
DZR2D Kč 790,- ..rozteč šroubů = 22 mm



DZR 7- P

DZR 7

..rozteč šroubů,-Abstand der Bolzen -
Screw pitch = 32 mm

DZR 7-P neotočný držák,- Nicht-Spiegelrotation

DZR 7-P Kč 550,- pro zrcátka,-für Spiegel,-for mirrors :
ZR7, ZR12, ZR19

DZR 7 otočný držák,-Schwenkkonsole

DZR 7 Kč790,- pro zrcátka,-für Spiegel,-for mirrors :
ZR7, ZR12, ZR19



DZR 12-P

M6

DZR 12 - P neotočný držák,- Nicht-Spiegelrotation

DZR 12-P Kč 660,- pro zrcátka,-für Spiegel,-for mirrors :
ZR1, ZR2B, ZR9, ZR9K, ZR12N, ZR19N



..rozteč šroubů,-
Abstand der
Bolzen,-spacing
of of screws =
51,5 mm

DZR 16

DZR 16 neotočný držák,- Nicht-Spiegelrotation

DZR 16 Kč 660,- pro zrcátka,-für Spiegel,-for mirrors : **ZR 16**

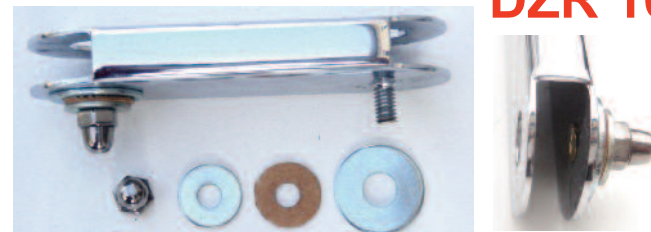

..rozteč šroubů,-
Abstand der
Bolzen,-spacing
of of screws =
50 mm

DZR 17



DZR 17 neotočný držák,- Nicht-Spiegelrotation

DZR 17 Kč 660,- pro zrcátka,-für Spiegel,-for mirrors : **ZR 17**

Držáky jsou vyrobeny s chromovaného nerezů,- Halter sind aus verchromtem Edelstahl,- Holders are made of chrome-plated stainless steel

Držáky jsou určeny k montáži na sklo 5-6mm, kůže,nebo guma nejsou součástí dodávky,-Die Klammern zur Befestigung an Glas 5-6 mm. Leder, Gummi, enthalte nicht,

Zpětná zrcátka - Rückblickspiegel - Driving Mirrors

ZR30-L (levé, links, left)

ZR30-P (pravé, recht, right)

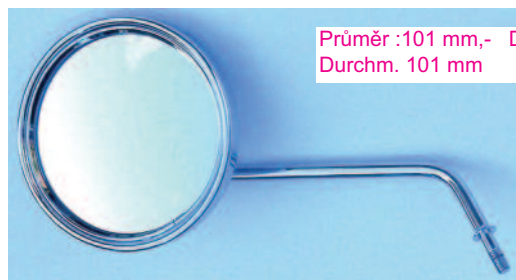

Průměr :101 mm,- Diameter: 101 mm
Durchm. 101 mm

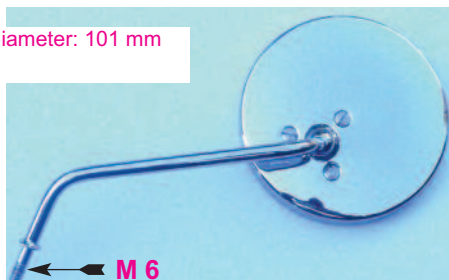

Zpětné zrcátko pro montáž na řídítka motocyklu na místo šroubku páčky spojky, nebo brzdy.



ZR 30-L Kč2450,-

ZR31 - 1932 - 1945 -



ZR 31-L Kč3490,-

Průměr : 99 mm, Diameter: 99 mm,
Durchm. 99 mm



Umístění na vozidle, Positionen am Fahrzeug,
Placing on the vehicle

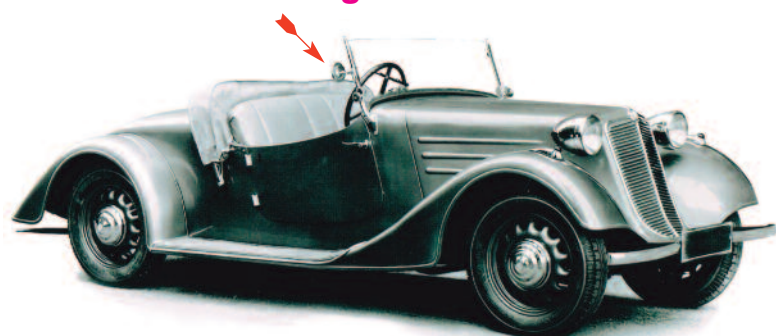

TATRA 57a - 1936

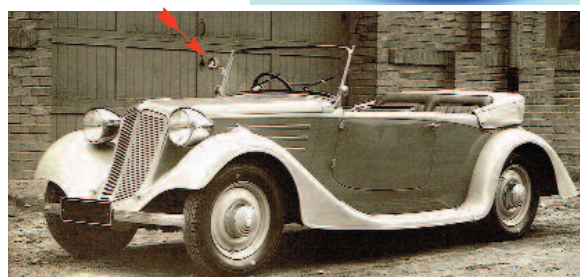

TATRA 75 - 1935

ZR32 - 1935 - 1940 -

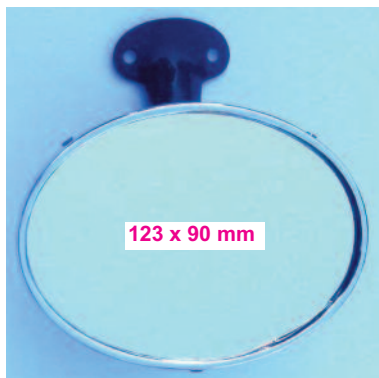

ZR 32 Kč 3130,-

ZR33 Průměr : 104 mm, Diameter: 104 mm, Durchm. 104 mm - 1934 - 1945 -



ZR 33 Kč 2380,-

